

(2012 / 2/ 14 2011/ 12 /13 )

.V

( 110 90 40)

.% 14 12

## **The Effect of Macroscopic Texturing in one Dimension on the Characteristics of Amorphous Silicon Solar Cells**

**Shema Kadir Ismeal**

**Bassam M. Mustafa**

*Department of Physics  
College of Science  
University of Mosul*

### **ABSTRACT**

In this research studied the effect of macroscopic texturing on the characteristics of amorphous silicon solar cells. The texturing is in the form of long grooves with shape V and of groove angles (acute, right, obtuse) (40, 90, 110 ) a theoretical method is found to calculate the increase of photo current due to increase of optical energy trapped by texturing. Our study concentrate on the case when the solar panels exist in its practical situation and for the coordinates of Mosul city for the four season of the year. For acute

angles there is no increase of efficiency, but for the right and obtuse angle the efficiency reach 12 and 14 % .

**Keywords** : macroscopic texturing, amorphous silicon solar cells, light trapping.

.( Dobrazanski and Dry gala, 2008)

(Photovoltaic Effect)

(Hovel, 1975)

2007 (Chopra *et al.*, 2004) 24.7% (c-Si)  
 .( Park, 2009) 4% (2.8 GW<sub>P</sub> )

(Silicon Wafer)

.(Chopra *et al.* , 2004)

( RCA)

( Carlson and Wronski,1976 )

(a-Si-H)

%10

1.1%

(Carlson, 1984 )

2010

.( Lund *et al.*, 2008) 11.5%

.(Green *et al.*, 2009) 11.7%

( Kaneka)

.V

( )

(1)

(i)  $n^+ - i$   $p^+ - i$   
 (i) (L)  
 (J<sub>P</sub>) (photoconductive layer)

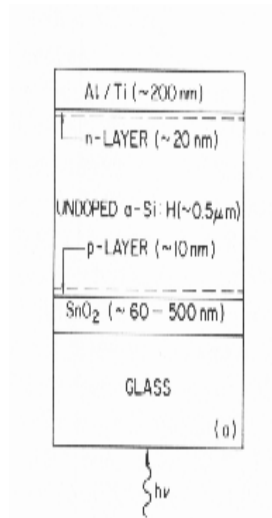
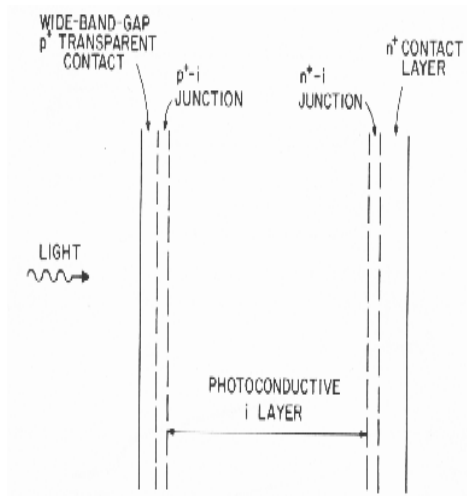

-b-

-a-

(glass/SnO<sub>2</sub>/p-i-n/Ag)

(a) : 1

(Swartz, 1984)

(b)

$$J = qG(\lambda)l_c [1 - \exp(-d/l_c)] \dots \dots \dots (1)$$

$$l_c \quad (i) \quad d \quad q$$

(Faughnan et al., 1984) :

$$l_c = \mu_n \tau_n \varepsilon + \mu_p \tau_p \varepsilon \dots \dots \dots (2)$$

$$\tau_p \quad \tau_n \quad \mu_p, \mu_n$$

$\varepsilon$

:( - ) - :G (λ)

$$G(\lambda) = \alpha(\lambda)N(\lambda)[1 - R(\lambda)]\exp(-\alpha(\lambda)x) \dots\dots\dots(3)$$

:  $\alpha(\lambda)$   
 :  $x$   
 :  $N(\lambda)$   
 :  $R(\lambda)$

(1a) ( a-Si: H )

$$J_T = J_p - J_d \dots\dots\dots(4)$$

$$J_d = nql / \tau_n \dots\dots\dots(5)$$

.( Carlson, 1984 ) :

( I-V )

$$V = -R_c J_T - \frac{V_s(1 - 0.5\sqrt{J_T/J_p})}{J_p/J_T - 1} - \frac{\beta kT}{q} \ln(1 - \frac{J_T}{J_p})^{-1} + V_{oc} \dots\dots\dots(6)$$

(Mustafa, 2009)

$R_2, J_{p2}$

$, R_1, J_{p1}$

$$J_{p2}/J_{p1} = [1 - R_2]/[1 - R_1] \dots\dots\dots(7)$$

$$J_{T1} = J_{pT1} \times \frac{84}{87} \dots\dots\dots(8)$$

$J_{T1}, J_{Pr1}$

.(Mustafa, 2009)

.....  
**Reflectivity Calculation**

2 .

(Hegedus *et al.*, 2002 )

: AM1.5

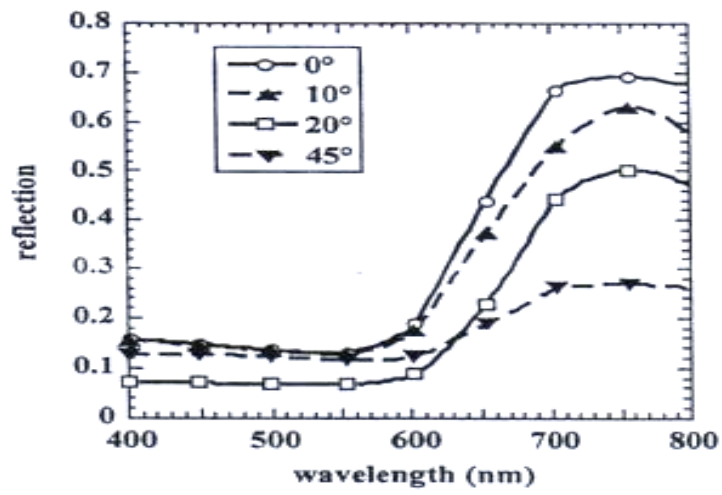

: 2

( ) (Hegedus *et al.*, 2002)

40 20 10

AM0 ( AM0 AM1.5 )

3

AM1.5

(Air mass zero)

( Air mass 1.5 )

.( 10 9 )

( Matlab)



.....

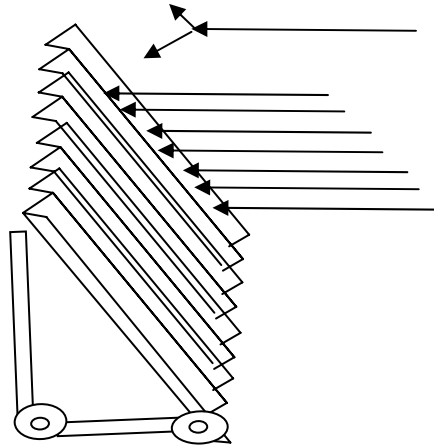

:4

$$(4)$$

(Z)

(H)

$$\cos D = \sin 23.5 \sin \frac{360 \times X_n}{365.25} \dots\dots\dots (11)$$

$$\cos Z = \cos D \cos L + \sin D \sin L \cos H \dots\dots\dots (12)$$

$X_n$  (Co latitude) (L)

21

$$\tan A = \sin D \sin H (\sin D \sin L \cos H - \cos D \sin L) \dots (13)$$

A  
(H)

(D)

$J_p$

( $P_{in}$ )

( $P_{out}$ )

( $\eta$ )

(2000)

)

( 25 )  
 (I-V) -  
 (1) ( - - )  
 (J<sub>p</sub>) (13 12 11) (A) (Z) (H)  
 $\alpha$  ( $2\alpha=40^\circ$ ) (8) (J<sub>T</sub>) 8 7  
 (12 11.5 11 10.5 10 9)  
 ( Excel) (I-V) - (5)  
 (I-V) - (6)  
 ( $\eta$ ) ( $p_{out}$ )  
 .(5)

( ) ( ) ( ) : 1  
 $40^\circ$   $\eta$

ساعات النهار قيود الدراسة	H درجة	Z درجة	A درجة	I <sub>p</sub> mA	I mA	P <sub>in</sub> Watt	P <sub>out</sub> Watt	$\eta$
9	45	42.789	79.352	1.325	1.280	0.07044	0.000625	0.008871
10	30	31.217	65.645	4.903	4.734	0.08209	0.002251	0.027421
10.5	22.5	25.927	55.771	7.377	7.122	0.08633	0.003357	0.038896
11	15	21.438	42.291	12.024	11.609	0.08935	0.005342	0.059794
11.5	7.5	18.009	23.510	13.599	13.130	0.09129	0.005970	0.065402
12	0	16.741	0	13.712	13.230	0.09193	0.006018	0.065461



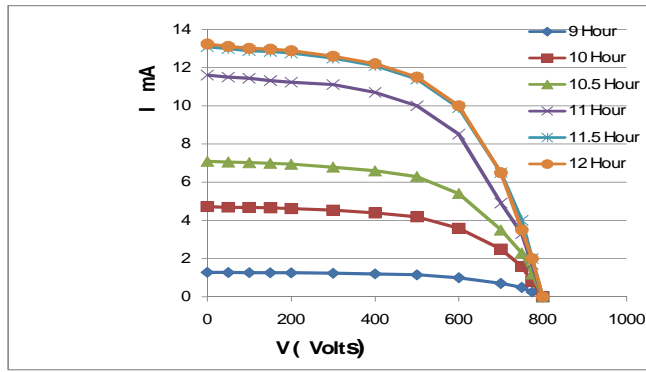

40° (I-V) - : 5

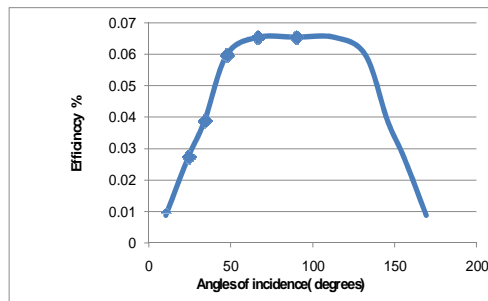

40° : 6

(110 -70) % 6.5

(6)

(90°)

(40°)

$I_p$

(2)

$I_T$

(90°)

(I-V) -

7

$p_{out}$

(I-V) -

( ) ( ) :2  
 . 90°

	<b>J<sub>P</sub></b> <b>mA</b>	<b>I</b> <b>mA</b>	<b>P<sub>in</sub></b> <b>Watt</b>	<b>P</b> <b>Watt</b>	<b>η</b>
9	3.276	3.163	0.07044	0.001532	0.021744
10	8.101	7.822	0.08209	0.003682	0.044850
10.5	11.286	10.897	0.08633	0.005018	0.058124
11	15.465	14.932	0.08935	0.006741	0.075444
11.5	21.179	20.448	0.09129	0.008934	0.097850
12	28.348	27.371	0.09193	0.011456	0.124616

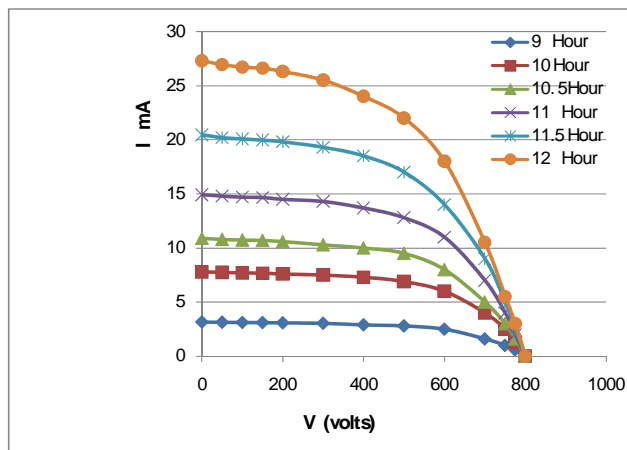

90° (I - V) - :7

8

(0.0119) Watt (12)

.....

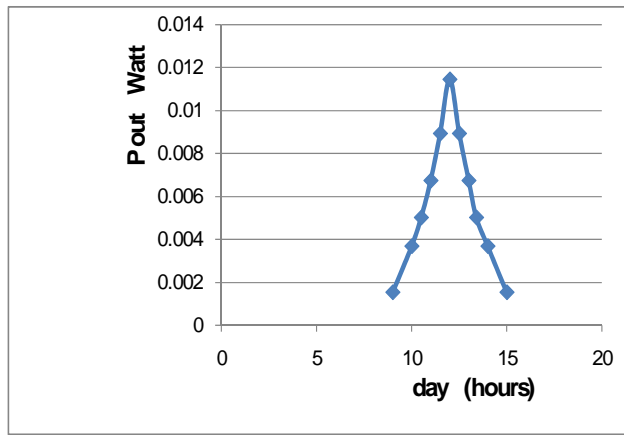

90°

:8

( 9 ) (90°)  
 (%12.5)

( 125 - 75)

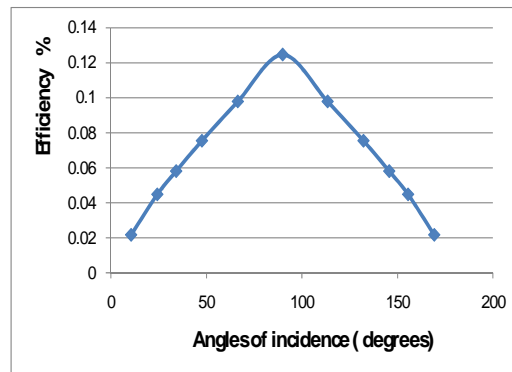

90

:9

(110°)

10

3

( 110°)

( I-V )

Pout

( ) ( ) : 3  
 110°

	<b>I<sub>p</sub> mA</b>	<b>I<sub>T</sub> mA</b>	<b>P<sub>in</sub> Watt</b>	<b>P<sub>out</sub> Watt</b>	<b>η</b>
9	3.145	3.036	0.07044	0.001471	0.020881
10	10.208	9.856	0.08209	0.004587	0.055875
10.5	13.737	13.263	0.08633	0.006004	0.069545
11	18.781	18.133	0.08935	0.008007	0.089619
11.5	25.022	24.166	0.09129	0.010313	0.112963
12	32.840	31.708	0.09193	0.012914	0.140474

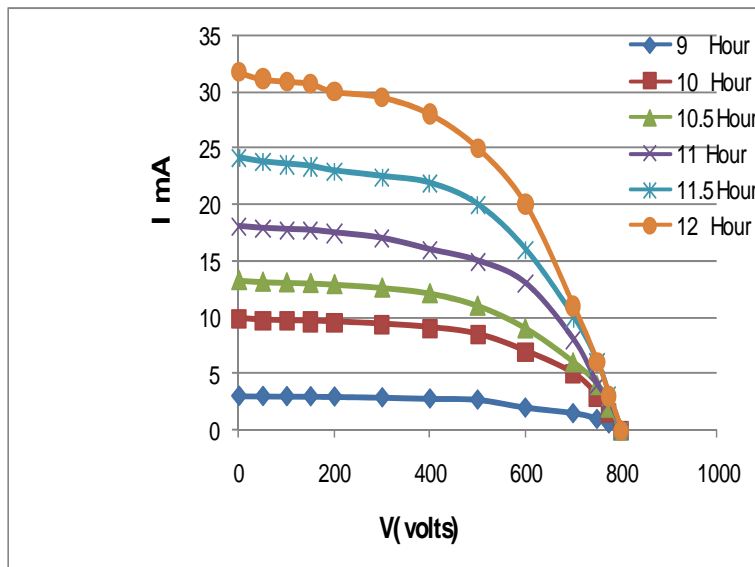

110° (I-V) - :10

11

(0.0130) Watt/cm<sup>2</sup>

(90° 40°)

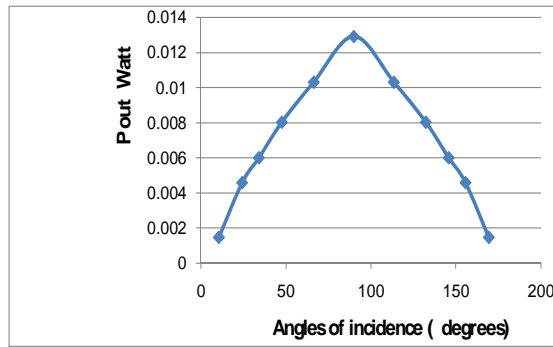

110°

: 11

12

40°

(%14)

(120 -60)

(%12.5 %6.5 )

(90°

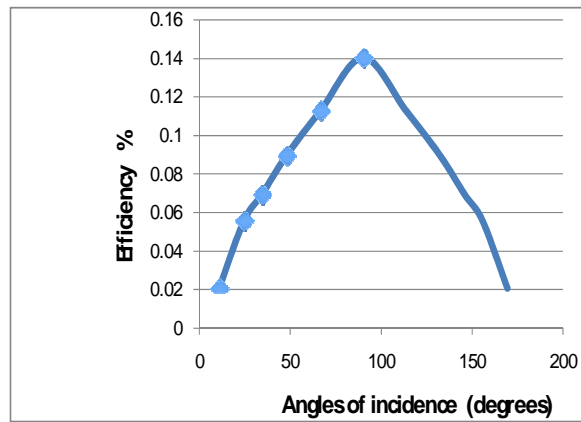

(110°)

: 12

J<sub>p</sub>

( 1)

)

(12 11.5 11 10 9 8)

(P<sub>out</sub>)

( p<sub>in</sub> )

(

(I-V) - ( - - )  
 ( 1) 13  
 40° (110° 90° 40°)  
 (120- 60)  
 (0.0044) Watt 90  
 (0.0050) Watt 110°  
 (0.0031) Watt  
 (90° -40°)

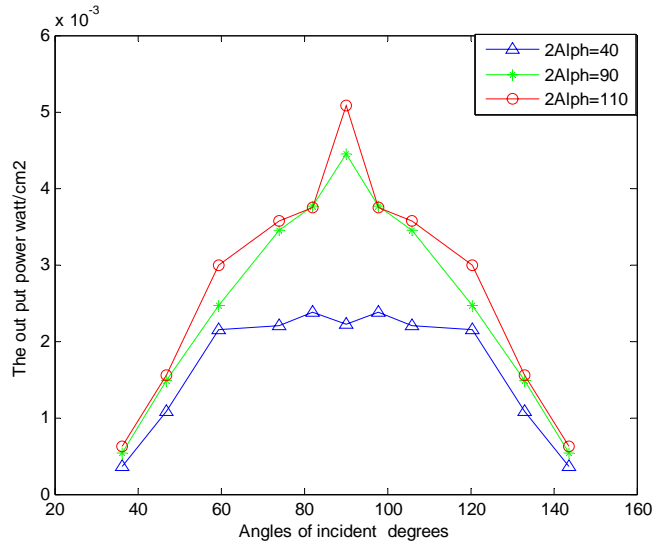

: 13

( 110 90 40)

14

(8%) (40°) (110° 90° 40°)  
 90°  
 110° (110 -70) (14%)  
 .(16% ) (130- 50)

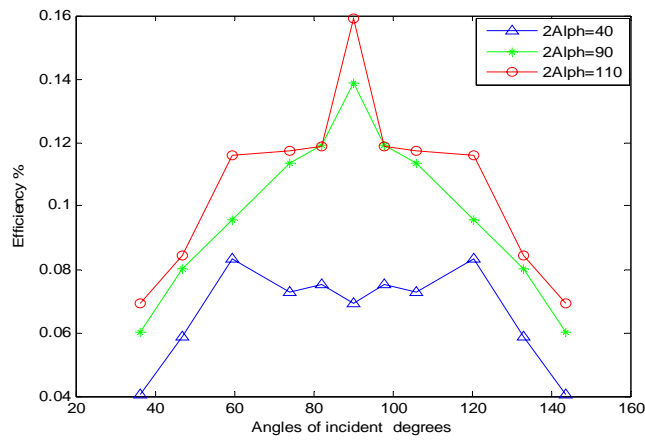

: 14

(40°)

15

(130-50)

( )

(150 -30)

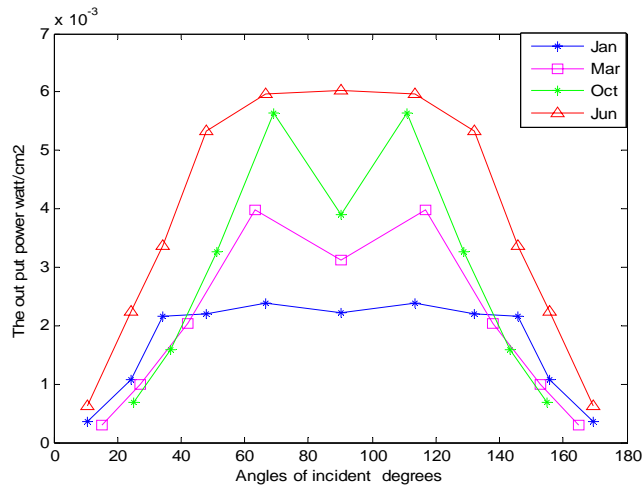

(40°)

:15

(90°)

16

)

(90°)

(

(120 -60)

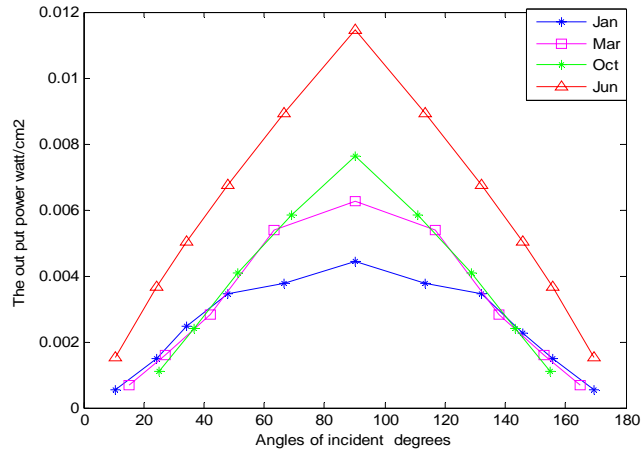

(90°)

:16

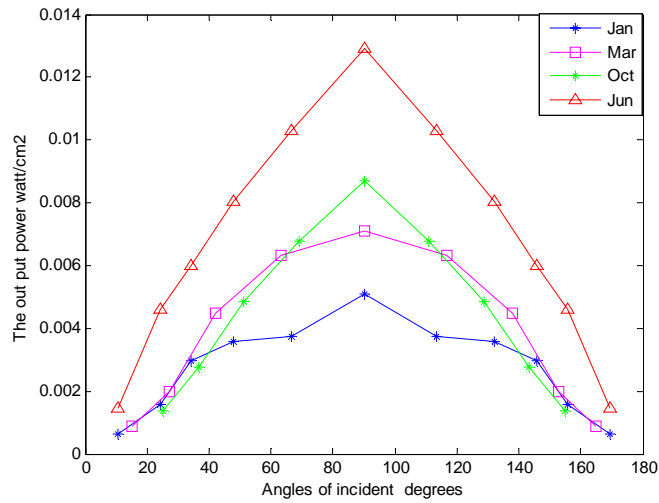

(110°)

:17

(110°)

17

(90°)

Watt

(0.0130) Watt/cm<sup>2</sup>

(90°)

(0.0050)

:



-1

-2

-3

-4

(110°)

-5

.( 2000)

.(2)11

" .( 1989)

- Carlson, D. E. (1984). " Solar cells, In Semiconductors and Semimetals Hydrogenated Amorphous Silicon ". Edited by P. J. I. Pankove ,Vol. 21, Part D, Academic Press, New York. pp.8-37.
- Carlson, D. E. ; Wronski, C. R. (1976). "Amorphous Silicon Solar Cell", *Applied Physics. Lett.* **28**, 673-689.
- Chopra, K. L.; Paulson, P.D.; Dutta, V. (2004). "Thin Film Solar Cells: An Over View",**12**, pp.69-92.
- Dobrazanski, L. A. ; Dry gala, A. (2008). Surface texturing of multi crystalline silicon solar cells. *J. Achievements in Materials and Manufacturing Engi.* , **31**(1),77-82.
- Faughnan, A.; Crandall, R. (1984). "Relationship Between Collection Length and Diffusion in Amorphous Silicon". *Applied Physics. Lett.* **44**(6), 612-613.
- Green, M. A.; Emery, K.; Hishikawa, Y. ; Warta , W. (2009). "Solar Cell Efficiency Tables in Ltd". Prog. Photovolt: Res. Appl. 2009 , John Wiley and Sons .
- Hegedus, S.; Paulson, P. D.; Sopori, B. (2002). "Optical Design and Analysis of Textured a-Si Solar Cells ". Mid West Research Institute: New Orleans.pp.2-3.
- Hovel, H. J. (1975). **11**, Solar cell, "In Semiconductor and Semimetals". edited by R .K. Willard son and A .C . Beer, Academic Press, New York, San Francisco , London .
- Lund, H. ; Nielsen, R. ; Salomatova, O.; Skare, D.; Riisem, E. (2008). "The History High Light of Solar Cells (Photovoltaic Cells)". <http://www.SolarCells.com>.
- Mustafa, B. M. (2009). "The effect of texturing on the efficiency of a-silicon solar cell", *Raff. J.Sci.* **20**(3),2-10.
- Park , J. (2009). [jepark@alumni.ucsd](mailto:jepark@alumni.ucsd). Front End Product Group Applied Materials
- Swartz ,G. A. (1984). "Closed- From Solution of( I-V) characteristics for a-Si-H Solar Cells, In semiconductors and semimetals hydrogenated amorphous silicon". Edited by P.J.I . Pankove , Vol. 21, Part D, Academic Press , New York. pp. 43-51.